



XStream™ Water-cooled screw chillers and Water/Water Heat pumps

Models

RTWF 275 – 515 (935 to 1860 kW)

RTHF 330 – 640 (1155 to 2220 kW)

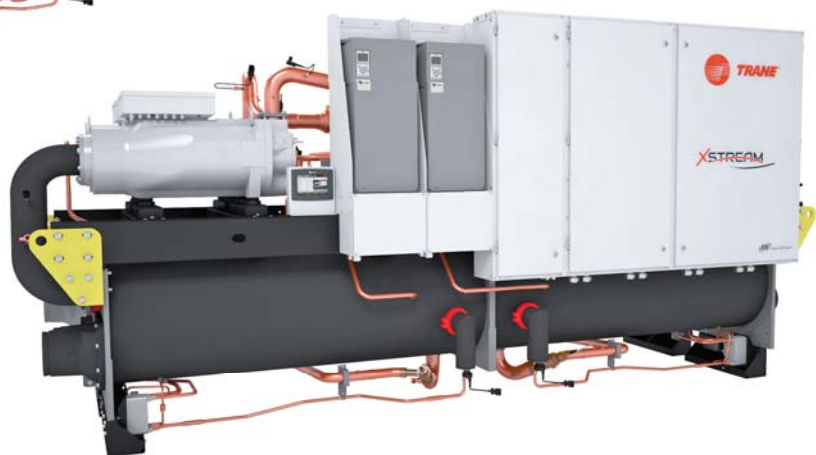

RLC-PRC058B-GB

Table of Contents

Introduction	4
Feature and benefits.....	5
Base unit description	8
Options description.....	9
Part load efficiency calculation.....	11
General data.....	12
Heating performance.....	17
Operating maps	18
Pressure drops	19
Electrical data	25
Acoustic data	26

Introduction

The new **Trane XStream™** series is the result of a search for higher reliability and higher energy efficiency, for today's environment.

In an effort to reduce energy consumed by cooling and heating equipment and to continually operate, Trane has developed the **XStream** series chillers and heat pumps with higher efficiencies and a more reliable design than any other water-to-water equipment available on the market today.

The **XStream** series uses the proven design of the Trane helical-rotary compressors, which embraces all of the design features that have made the Trane helical-rotary compressor liquid chillers such a success since 1987.

The industrial-grade design of this helical rotary chillers and heat pumps is ideal for both industrial and commercial markets, in applications such as office buildings, hospitals, schools, retail buildings, and industrial facilities.

The major advantages of the **XStream** series are:

- Extended and unmatched capacities
- High efficiencies both in cooling and heating
- 99.5% reliability rate
- Suitable with high condensing temperature and heat pump applications with possible delivery of hot water up to 68°C (RTWF)
- Great versatility to adapt to varying applications requirements

XStream series come in several versions and efficiency levels, to allow customers to make the best choice according to his main criteria, whether they are economical or environmental.

RTWF offers 3 efficiency levels

- Standard Efficiency (SE),
- High Efficiency (HE),
- High Seasonal Efficiency (HSE), featuring Trane Adaptive Frequency Drive (AFD) to reach High Part Load Efficiencies (ESEER)

RTHF offers 2 efficiency levels

- Extra Efficiency (XE)
- High Seasonal Efficiency (HSE), featuring Trane Adaptive Frequency Drive (AFD) to reach the highest Part Load Efficiencies (ESEER)



RTWF



RTHF

Features and benefits

Trane Helical-Rotary Compressors

- **Unequaled-reliability.** Trane helical-rotary compressor are designed, built, and tested to the same demanding and rugged standards as the previous generation helical-rotary compressors used in both air- and water-cooled chillers for more than 27 years.
- **Years of research and testing.** The Trane helical-rotary compressors have amassed thousands of hours of testing, much of it at severe operating conditions beyond normal commercial air- conditioning applications.
- **Proven track record.** The Trane Company is the world's largest manufacturer of large helical-rotary compressors used for refrigeration. Over 300,000 compressors worldwide have proven that the Trane helical- rotary compressors have a reliability rate of greater than 99.5% in the first year of operation — unequaled in the industry.
- **Resistance to liquid slugging.** The robust design of the Trane Series R™ compressor can ingest amounts of liquid refrigerant that normally would severely damage compressor.
- **Fewer moving parts.** The helical- rotary compressor has only two rotating parts: the male rotor and the female rotor.
- **Direct-drive, low-speed,** semi- hermetic compressor for high efficiency and high reliability.
- **Field-serviceable compressor** for easy maintenance.
- **Suction-gas-cooled motor.** The motor operates at lower temperatures for longer motor life.
- **Five minute** start-to-start and two minute stop-to-start anti-recycle timer allows for closer water-loop temperature control.

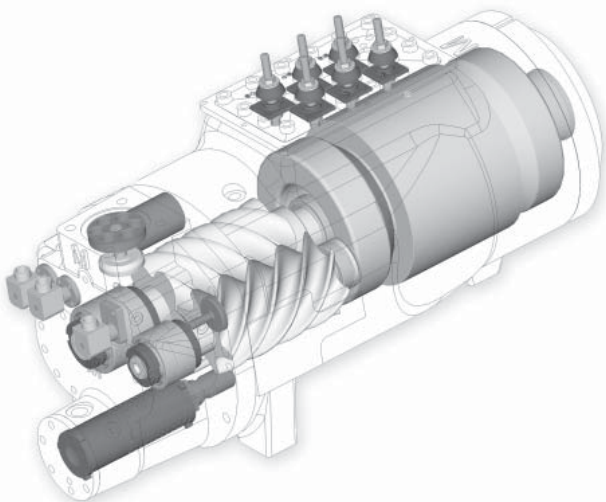

Trane GP2 compressor

Capacity Control and Load Matching

The combination patented unloading system on Trane helical- rotary compressors uses the variable unloading valve for the majority of the unloading function. This allows the compressor to modulate infinitely, to exactly match building load and to maintain chilled-water supply temperatures within $\pm 0.3^{\circ}\text{C}$ of the set point. Helical-rotary chillers that rely on stepped capacity control must run at a capacity equal to or greater than the load, and typically can only maintain water temperature to around $\pm 1^{\circ}\text{C}$. Much of this excess capacity is lost because overcooling goes toward removing building latent heat, causing the building to be dried beyond normal comfort requirements.

On RTWF and RTHF HSE version, the combination of the variable unloading valve plus the Adaptive Frequency™ drive allows exactly matching building load and getting excellent efficiencies at full load and part load.

HSE units (AFD equipped) are fully compliant with Class C3 (Industrial environment) requirements of EN61800-3 standard.

CHIL evaporator

Trane developed an evaporator specially designed for **XStream** chillers. Compact - High performance - Integrated design - Low charge (CHIL) evaporator optimizes the flow of the refrigerant to get an excellent heat exchange with water in every operating condition and minimize the quantity of refrigerant used.

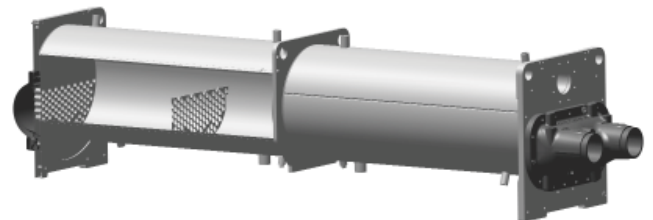

High Lift applications

When considering heat pump or low leaving temperatures industrial process applications, compressor operates under severe pressure conditions, which, if not anticipated may be harmful for compressor or considerably decrease life and reliability of compressor. For high lift applications, **XStream** RTWF units, feature a dedicated compressor design to keep up with those harsh operating conditions. Therefore, RTWF units can reach temperatures as low as -12°C on the evaporator side or as high as 68°C on the condensing side, yet keeping high efficiency and premier reliability.



Features and benefits

Variable Primary Flow

An attractive chilled-water system option may be a variable primary flow (VPF) system. VPF systems present building owners with several cost-saving benefits that are directly related to the pumps. The most obvious cost savings result from eliminating the secondary distribution pump, which in turn avoids the expense incurred with the associated piping connections (material, labor), electrical service, and variable-frequency drive.

Building owners often cite pump related energy savings as the reason that prompted them to install a VPF system. With the help of a TRANE software analysis tool, you can determine whether the anticipated energy savings justify the use of variable primary flow in a particular application. It may also be easier to apply variable primary flow in an existing chilled-water plant.

Unlike the “decoupled” design, the bypass can be positioned at various points in the chilled-water loop and an additional pump is unnecessary. The evaporator in the **XStream** series can withstand up to 50% percent water flow reduction as long as this flow is equal to or above the minimum flow-rate requirements. The microprocessor and capacity control algorithms are designed to handle a maximum of 10% change in water flow rate per minute in order to maintain $\pm 0.3^{\circ}\text{C}$ leaving evaporator temperature control. For applications in which system energy savings is most important and tight temperature control is classified as $\pm 1.1^{\circ}\text{C}$, up to 30% changes in flow per minute are possible.

Factory Testing Means Trouble-Free Start-up

All **XStream** chillers are given a complete functional test at the factory. This computer-based test program completely checks the sensors, wiring, electrical components, microprocessor function, communication capability, expansion valve performance, and fans. In addition, each compressor is run-tested to verify capacity and efficiency. Where applicable, each unit is factory preset to the customer’s design conditions. An example would be the leaving-liquid temperature set point. The result of this test program is that the chiller arrives at the job site fully tested and ready for operation.

Factory-Installed and Tested Controls and Options Speed Installation

All **XStream** chiller options are factory installed and tested. Some manufacturers send accessories in pieces to be field installed. With Trane, the customer saves on installation expense and has assurance that ALL chiller controls and options have been tested and will function as expected.

Superior Control with UC 800™ Chiller controls

The Adaptive Control™ microprocessor system enhances the **XStream** chiller by providing the very latest chiller control technology. With the Adaptive Control microprocessor, unnecessary service calls and unhappy tenants are avoided. The unit does not nuisance-trip or unnecessarily shut down. Only when the chiller controls have exhausted all possible corrective actions and the unit is still violating an operating limit, will the chiller shut down. Controls on other equipment typically shut down the chiller, usually just when it is needed the most.



Features and benefits

SmartFlow control

XStream series units are fully compatible with variable flow operation both on evaporator and condenser sides. The modulation of the pump speed is managed to ensure that chiller ΔT stays constant. Entering and leaving temperatures at the evaporator will be measured directly by the chiller controller, through the factory-supplied sensor. A ΔT setpoint will be present on the unit controller. The option for constant ΔT is intended to be used with 3-way valves on water systems, or 2-way valves on water system but constant flow at the by-pass.

System option: Ice storage

UC 800 optimization software controls operation of the required equipment and accessories to easily move from one mode of operation to another. For example: even with ice-storage systems, there are numerous hours when ice is neither produced nor consumed, but saved.

In this mode, the chiller is the sole source of cooling. For example, to cool the building after all ice is produced but before high electrical demand charges take effect, UC 800 sets the chiller leaving- fluid set point to its most efficient setting and starts the chiller, chiller pump, and load pump.

When electrical demand is high, the ice pump is started and the chiller is either demand limited or shut down completely. UC 800 controls have the intelligence to optimally balance the contribution of the ice and the chiller in meeting the cooling load.

The capacity of the chiller plant is extended by operating the chiller and ice in tandem. UC 800 rations the ice, augmenting chiller capacity while reducing cooling costs. When ice is produced, UC 800 will lower the chiller leaving-fluid set point and start the chiller, ice and chiller pumps, and other accessories. Any incidental loads that persist while producing ice can be addressed by starting the load pump and drawing spent cooling fluid from the ice storage tanks.

For specific information on ice storage applications, contact your local sales office

Series counterflow chiller configuration

When considering multiple chillers plant, designers conventionally go for parallel-piped chillers configuration. Nevertheless, there are ways to bring more efficiency by using a different chiller lay-out.

An effective alternative to consider is to pipe the chillers in series. Larger ΔT and low flow design save energy on the pumping. Series chiller configuration allows as well, to get a better efficiency from the upstream chiller, more lightly loaded. Combining this configuration with Variable Primary Flow (VPF) will further increase system efficiency.

Series piping principle can also be applied to condenser side. This is called Series-Series counterflow configuration. This will result in similar advantages on the condenser side, enlarging the opportunity for savings on the overall system.

For more information on Series chillers arrangements, refer to Trane Application Engineering Manual about Multiple-Chiller system design and control (SYS-AP M001).

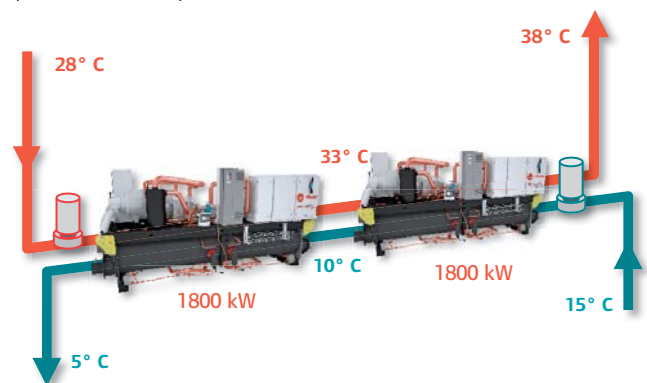

Product certification

Trane as a Global leader in the HVAC industry participates to both Eurovent and AHRI chillers certification programs. Through this third party certifications, Trane commits to deliver units that comply with the declared performance.



Base unit description

	RTWF SE	RTWF HE	RTHF XE	RTWF HSE	RTHF HSE
Power supply	400 V - 3 Ph - 50 Hz - Single point				
Compressor type	Trane CHHP		Trane CHHC	Trane CHHP	Trane CHHC
Compressor technology	Fixed speed			AFD	
Number of circuits	2				
Compliance	CE - PED				
Condenser application	Cooling : Entering Condenser Water Temp \leq 35°C Heating: Low temp Water to Water HP operation				
Evaporator application	Cooling - Leaving Evaporator Water Temp \geq 4.4°C				
Refrigerant	R-134a				
Relief valve	Single relief valve on condenser				
Evaporator water connections	Direct Connection - Grooved pipes				
Evaporator water side pressure	10 bars				
Condenser water connections	Direct Connection - Grooved pipes				
Condenser water side pressure	10 bars				
Flow Control	Constant Flow - Pump signal On/Off (Condenser + Evaporator)				
Power protection	Fused				
Electrical IP protection	Enclosure with Dead Front protection				
Installation accessories	Optional				

Options description

Option Description	Application	Available for		
		RTWF	RTHF	
400 V - 3 Ph - 50 Hz - Dual point	2 distinct power supplies, one per circuit	Renovation. Replacement of two smaller units by one only.	-	●
Condenser Application				
High Temp Condenser	Compressor design optimized for high compression ratio	Dry cooler applications with up to 68°C Condenser leaving water	●	-
Med & High temp water to water HP operation	Compressor design optimized for high compression ratio + Condenser leaving water temperature control	Heat pump applications with Leaving water up to 68°C	●	-
Low temp water to water heat pump operation	Condenser Leaving water temperature control	Heat pump applications with condenser entering water temperature up to 35°C	●	-
Evaporator Application				
Process Cooling - Leaving Evaporator Water Temp < 4.4°C	Compressor design optimized for high compression ratio	Process cooling applications down to -12°C leaving water	●	●
Ice making	Compressor design optimized for high compression ratio + Dual setpoint (Comfort / Ice making)	Ice storage applications for Ice making temps as low as -7°C	●	●
Sound Attenuation Package	Additional compressor sound enclosure	Sound reduction of 3 dB(A) per Compressor	●	-
Relief Valve				
Single relief Valve on both condenser and evaporator	Additional relief valve on Low pressure side	Additional pressure safety device	●	●
Dual Relief valve on condenser only	2 relief valve with by 3 way valve on high pressure side	Maintenance	●	●
Dual relief Valve on both evaporator and condenser	2 relief valve with by 3 way valve on both high and low side	Maintenance	●	●
Evaporator water connection				
Left hand Connection	Additional pipe allowing Evaporator connections on the right side of the unit (facing control panel)	Supply and return water on the same side of the unit	●	●
Right hand Connection	Additional pipe allowing Evaporator connections on the left side of the unit (facing control panel)	Supply and return water on the same side of the unit	●	●
No insulation on cold parts	Unit delivered without insulation on Evaporator and cold parts	For field supplied insulation by customer	●	●
Condenser water connection				
Left hand Connection	Additional pipe allowing Condenser connections on the right side of the unit (facing control panel)	Supply and return water on the same side of the unit	●	●
Right hand Connection	Additional pipe allowing Condenser connections on the left side of the unit (facing control panel)	Supply and return water on the same side of the unit	●	●
Condenser thermal insulation	Thermal insulation of condenser	Heat Pump application to avoid wasted heat	●	●
SmartFlow Control				
VPF Constant Delta T Evaporator	Optional PC board delivering a 2-10 V modulating signal output to control a pump motor speed inverter	Evaporator variable speed pump control based on a constant Delta T	●	●
VPF Constant Delta T Condenser	Optional PC board delivering a 2-10 V modulating signal output to control a pump motor speed inverter	Condenser variable speed pump control based on a constant Delta T	●	●
VPF Constant Delta T Evaporator and Condenser	Optional PC board delivering a 2-10 V modulating signal output to control a pump motor speed inverter	Evaporator and Condenser variable speed pump control based on constant Delta T's	●	●
Power protection	Unit protection by Circuit Breaker	Protection of compressors against over current	●	●

● Factory mounted ▲ Accessory (not fitted) - Not proposed

Options description

Option Description	Application	Available for	
		RTWF	RTHF
Under/over voltage protection			
Under/Over voltage protection	Phase monitoring device	●	●
Under/Over voltage protection + ground fault protection	Phase monitoring device + differential circuit breaker	●	●
Smart Com protocole			
BACNet MSTP interface	Communication card	●	●
BACNet IP interface	Communication card	●	●
ModBus RTU interface	Communication card	●	●
LonTalk Interface	Communication card	●	●
External setpoints & capacity outputs	Programmable Input/Output card and sensors	▲	▲
Outdoor Air Temp Sensor	With Outdoor Air Temp Sensor	▲	▲
Electrical IP Protection	IP 20 protection	●	●
Master slave operation	Communication card	●	●
Energy metering	Additional energy meter	●	●
Condenser Refrigerant Pressure Output			
Condenser Water Control Output	Communication card - 0-10 V Analog output	●	●
Condenser Pressure (%HPC) Output	Communication card - 0-10 V Analog output	●	●
Differential Pressure Output	Communication card - 0-10 V Analog output	●	●
Power socket	230 V Power socket	●	●
Anti vibration accessories			
Neoprene isolators		▲	▲
Neoprene pads		▲	▲
Grooved pipe with coupling & pipe stub	4 Grooved pipe adapters	▲	▲
Flow Switch			
Evap or Condenser Flow switch	One Flow Switch delivered to be installed either on Evaporator or Condenser side	▲	▲
Evap and Condenser Flow switch	Two Flow Switches delivered to be installed respectively on Evaporator and Condenser side	▲	▲

● Factory mounted ▲ Accessory (not fitted) - Not proposed

Part load efficiency calculation

Trane RTWF and RTHF are both Eurovent and AHRI certified:

Eurovent certification program certifies unit performances of units up to 1500 kW.

AHRI certification program certifies unit performances of units above 750 kW (200 tons).

ESEER (European Seasonal Energy Efficiency Ratio)

Eurovent expresses part load efficiency using ESEER.

ESEER is the weighted average of 4 net efficiencies (net EER) at 4 different operating conditions. Net EER is computed according to EN14511:2013 European standard.

EN14511:2013 defines Net performances by taking into account the impact of Heat exchangers water pressure drop (or pumps when delivered as an option) on overall power consumption.

Condition	A	B	C	D
% Part Load	100%	75%	50%	25%
Condenser Entering/Leaving water temp.(°C)	30 / 35	26 / *	22 / *	18 / *
Evaporator entering /Leaving water temp (°C)	12 / 7	* / 7	* / 7	* / 7
Operating time	3%	33%	41%	23%

* Temperature change depending on Nominal flow (100% Load).

To compute unit ESEER, use formula below:

$$\text{ESEER} = \text{net EER}_A \times 3\% + \text{net EER}_B \times 33\% + \text{net EER}_C \times 41\% + \text{net EER}_D \times 23\%$$

IPLV (Integrated Part Load Value)

AHRI expresses part load using IPLV.

IPLV is the weighted average of 4 gross efficiencies (gross EER) at 4 different operating conditions. IPLV is computed according to AHRI 551-591 Standard (SI Metric units).

Condition	A	B	C	D
% Part Load	100%	75%	50%	25%
Condenser Entering water temp (°C)	30	24.5	19	19
Condenser Temperature change (K)	5		*	
Evaporator Leaving water temp (°C)	7	7	7	7
Evaporator Temperature change (K)	5		*	
Operating time	1%	42%	45%	12%

* Temperature change depending on Nominal flow (100% Load).

EER calculation is done using following fouling factors:

- Condenser: 0.0440 m²•K/kW
- Evaporator: 0.0180 m²•K/kW

To compute unit IPLV, formula below must be used:

$$\text{IPLV} = \text{Gross EER}_A \times 1\% + \text{Gross EER}_B \times 42\% + \text{Gross EER}_C \times 45\% + \text{Gross EER}_D \times 12\%$$



General Data

RTWF SE (Standard Efficiency)

		275 SE	290 SE	310 SE	330 SE	370 SE	410 SE	450 SE	490 SE
Gross Cooling Capacity (1)	kW	938.0	981.1	1040.2	1110.1	1247.2	1393.7	1533.6	1673.1
Gross power input (1)	kW	193.0	202.3	214.06	227.7	257.7	286.1	314.8	342.0
Gross EER (1)		4.96	4.95	4.96	4.97	4.94	4.97	4.97	4.99
Gross ESEER (1)		6.94	6.89	6.84	7.06	6.95	7.48	7.37	7.20
IPLV (1)		7.269	7.246	7.148	7.314	7.246	7.821	7.705	7.529
Net cooling capacity (2)	kW	934.5	977.2	1036.0	1105.7	1242.2	1388.2	1527.7	1666.7
Net power input (2)	kW	201.0	211.5	223.8	237.8	269.5	298.5	328.5	356.9
Net EER (2)		4.74	4.71	4.72	4.74	4.70	4.74	4.74	4.77
Net ESEER (2)		6.00	5.89	5.86	6.04	5.92	6.38	6.31	6.20
Min Load	%	20%	20%	20%	20%	20%	15%	15%	15%
Compressor									
Circuit 1		2	2	2	2	2	2	2	2
Circuit 2		1	1	1	1	1	2	2	2
Evaporator									
Pass		1							
Nominal Flow (1)(2)	l/s	44.7	46.8	49.6	52.9	59.5	66.4	73.1	79.8
Pressure Drop (1)(2)	kPa	53.3	58.1	57.8	58.8	58.6	58.9	58.4	58.8
Minimum Flow	l/s	18.0	18.0	19.1	20.4	23.3	25.2	28.0	31.0
Maximum Flow	l/s	65.9	65.9	70.2	74.9	85.3	93.0	103.0	113.0
Water Connection Type		Grooved end							
Water Connection Size	in	6	6	6	6	6	8	8	8
Condenser									
Pass		1							
Nominal Flow (1)(2)	l/s	53.3	55.8	59.2	63.1	71.0	79.3	87.2	95.1
Pressure Drop (1)(2)	kPa	60.5	66.0	64.4	64.4	72.1	67.1	69.4	67.8
Minimum Flow	l/s	17.8	17.8	19.3	20.8	22.2	24.8	27.1	30.2
Maximum Flow	l/s	65.2	65.2	70.7	76.3	81.4	91.0	99.5	110.7
Water Connection Type		Grooved end							
Water Connection Size	in	6	6	6	6	6	8	8	8
Refrigerant									
Type		R134a							
Charge Circuit 1	kg	161	161	155	163	163	145	150	155
Charge Circuit 2	kg	75	72	69	76	72	144	148	152
Dimensions & weight									
Length	mm	4754	4754	4784	4784	4784	4784	4784	4784
Width	mm	1727	1727	1727	1727	1727	1823	1823	1823
Height	mm	2032	2032	2032	2032	2032	2135	2135	2135
Operating weight	kg	5276	5273	5456	5511	5574	6945	7025	7109

- (1) Evaporator 12/7°C, condenser water temperature 30/35°C. Rated in accordance with AHRI Standard 551/591, based on TOPSS (Trane Official Product Selection Software) version 191.
- (2) Evaporator 12/7°C, condenser water temperature 30/35°C according to EN14511:2013.

General Data

RTWF HE (High Efficiency)

		275 HE	290 HE	310 HE	330 HE	370 HE	410 HE	450 HE	490 HE
Gross Cooling Capacity (1)	kW	962.5	1007.8	1071.6	1139.5	1272.1	1428.5	1568.9	1714.0
Gross power input (1)	kW	183.0	191.5	204.6	216.9	241.7	270.7	299.5	326.7
Gross EER (1)		5.37	5.37	5.35	5.36	5.37	5.39	5.35	5.36
Gross ESEER (1)		7.32	7.28	7.2	7.44	7.34	7.8	7.61	7.43
IPLV (1)		7.669	7.669	7.553	7.722	7.680	8.155	7.957	7.753
Net cooling capacity (2)	kW	959.4	1004.3	1068.3	1135.6	1266.9	1423.6	1563.5	1708.4
Net power input (2)	kW	188.5	197.3	210.7	223.6	249.4	279.1	309.0	336.3
Net EER (2)		5.19	5.19	5.17	5.18	5.18	5.20	5.16	5.18
Net ESEER (2)		6.61	6.52	6.47	6.65	6.54	6.99	6.82	6.71
Min Load	%	20%	20%	20%	20%	20%	15%	15%	15%
Compressor									
Circuit 1		2	2	2	2	2	2	2	2
Circuit 2		1	1	1	1	1	2	2	2
Evaporator									
Pass		1							
Nominal Flow (1)(2)	l/s	45.9	48.0	51.1	54.3	60.6	68.1	74.8	81.7
Pressure Drop (1)(2)	kPa	44.5	48.7	43.6	49.1	60.9	50.9	51.9	49.3
Minimum Flow	l/s	20.4	20.4	23.3	23.3	23.3	28.0	31.0	34.6
Maximum Flow	l/s	74.9	74.9	85.3	85.3	85.3	103.0	113.0	126.9
Water Connection Type		Grooved end							
Water Connection Size	in	6	6	6	6	6	8	8	8
Condenser									
Pass		1							
Nominal Flow (1)(2)	l/s	54.0	56.6	60.2	64.0	71.4	80.1	88.1	96.3
Pressure Drop (1)(2)	kPa	25.6	28.0	31.7	28.7	23.4	27.8	29.9	28.5
Minimum Flow	l/s	29.9	29.9	29.9	34.2	45.4	41.4	44.0	50.1
Maximum Flow	l/s	111.0	111.0	111.0	125.2	167.5	151.8	161.4	184.5
Water Connection Type		Grooved end							
Water Connection Size	in	6	6	6	6	6	8	8	8
Refrigerant									
Type		R-134a							
Charge Circuit 1	kg	190	190	193	191	185	176	183	183
Charge Circuit 2	kg	90	86	90	84	81	175	181	180
Dimensions & weight									
Length	mm	4754	4754	4784	4784	4784	4784	4784	4784
Width	mm	1727	1727	1727	1727	1727	1823	1823	1823
Height	mm	2032	2032	2032	2032	2032	2135	2135	2135
Operating weight	kg	5687	5683	5886	5950	6123	7446	7571	7694

- (1) Evaporator 12/7°C, condenser water temperature 30/35°C. Rated in accordance with AHRI Standard 551/591, based on TOPSS (Trane Official Product Selection Software) version 191.
- (2) Evaporator 12/7°C, condenser water temperature 30/35°C according to EN14511:2013.

General Data

RTWF HSE (High Seasonal Efficiency)

		275 HSE	290 HSE	310 HSE	330 HSE	370 HSE	410 HSE	450 HSE	490 HSE	515 HSE
Gross Cooling Capacity (1)	kW	964.1	1010.0	1071.5	1139.5	1263.0	1428.4	1568.7	1704.6	1863.7
Gross power input (1)	kW	186.8	195.4	209.9	222.1	245.9	276.0	304.9	331.2	375.3
Gross EER (1)		5.27	5.28	5.2	5.23	5.23	5.28	5.24	5.26	5.16
Gross ESEER (1)		7.54	5.73	5.52	7.46	7.62	7.77	7.49	7.49	7.68
IPLV (1)		7.832	7.831	7.898	7.834	8.058	8.292	7.990	8.033	8.002
Net cooling capacity (2)	kW	961.0	1006.5	1068.1	1135.6	1257.9	1423.5	1563.4	1699.1	1856.8
Net power input (2)	kW	192.2	201.3	216.2	229.0	253.6	284.1	313.9	340.5	386.8
Net EER (2)		5.10	5.10	5.04	5.06	5.06	5.11	5.08	5.09	4.90
Net ESEER (2)		6.81	6.74	6.76	6.69	6.81	7.01	6.85	6.7	6.78
Min Load	%	15%	15%	15%	15%	15%	15%	15%	15%	15%
Compressor										
Circuit 1		2	2	2	2	2	2	2	2	2
Circuit 2		1	1	1	1	1	2	2	2	2
Evaporator										
Pass		1								
Nominal Flow (1)(2)	l/s	46.0	48.1	51.1	54.3	60.2	68.1	74.8	81.3	88.9
Pressure Drop (1)(2)	kPa	44.7	48.9	43.6	49.1	60.0	50.9	51.9	48.8	58.0
Minimum Flow	l/s	20.4	20.4	23.3	23.3	23.3	28.0	31.0	34.6	34.6
Maximum Flow	l/s	74.9	74.9	85.3	85.3	85.3	103.0	113.0	126.9	126.9
Water Connection Type		Grooved end								
Water Connection Size	in	6	6	6	6	6	8	8	8	8
Condenser										
Pass		1								
Nominal Flow (1)(2)	l/s	54.2	56.7	60.3	64.1	71.0	80.3	88.3	95.9	105.5
Pressure Drop (1)(2)	kPa	25.8	28.2	31.8	28.8	23.2	27.9	29.9	28.3	34.0
Minimum Flow	l/s	29.9	29.9	29.9	34.2	45.4	41.4	44.0	50.1	50.1
Maximum Flow	l/s	111.0	111.0	111.0	125.2	167.5	151.8	161.4	184.5	184.5
Water Connection Type		Grooved end								
Water Connection Size	in	6	6	6	6	6	8	8	8	8
Refrigerant										
Type		R-134a								
Charge Circuit 1	kg	190	190	193	191	185	176	183	183	183
Charge Circuit 2	kg	90	86	90	84	81	175	181	180	179
Dimensions & weight										
Length	mm	4754	4754	4784	4784	4784	4784	4784	4784	4784
Width	mm	1727	1727	1727	1727	1727	1823	1823	1823	1823
Height	mm	2032	2032	2032	2032	2032	2135	2135	2135	2135
Operating weight	kg	5862	5858	6100	6164	6337	7660	7785	7908	7907

- (1) Evaporator 12/7°C, condenser water temperature 30/35°C. Rated in accordance with AHRI Standard 551/591, based on TOPSS (Trane Official Product Selection Software) version 191.
- (2) Evaporator 12/7°C, condenser water temperature 30/35°C according to EN14511:2013.

General Data

RTHF XE (Extra High Efficiency)

		330 XE	360 XE	410 XE	460 XE	500 XE	540 XE
Gross Cooling Capacity (1)	kW	1159.2	1266.3	1442.4	1571.2	1749.8	1886.1
Gross power input (1)	kW	202.2	223.5	254.1	279.8	310.6	333.1
Gross EER (1)		5.85	5.79	5.79	5.72	5.54	5.78
Gross ESEER (1)		7.29	7.23	7.07	7.2	7.23	7.31
IPLV (1)		7.772	7.738	7.485	7.594	7.622	7.739
Net cooling capacity (2)	kW	1155.8	1262.7	1438.7	1566.6	1745.0	1880.2
Net power input (2)	kW	207.1	228.8	260.2	287.4	319.0	343.1
Net EER (2)		5.69	5.63	5.64	5.56	5.58	5.59
Net ESEER (2)		6.77	6.72	6.59	6.63	6.64	6.65
Min Load	%	15%	15%	15%	15%	15%	15%
Compressor							
Circuit 1		1	1	1	1	1	1
Circuit 2		1	1	1	1	1	1
Evaporator							
Pass		1					
Nominal Flow (1)(2)	l/s	55.3	60.4	68.8	74.9	83.4	89.9
Pressure Drop (1)(2)	kPa	41.2	40.3	36.7	43.4	41.0	47.5
Minimum Flow	l/s	25.2	28.0	34.0	34.0	39.2	39.2
Maximum Flow	l/s	93.0	103.0	124.8	124.8	143.7	143.7
Water Connection Type		Grooved end					
Water Connection Size	in	8	8	8	8	8	8
Condenser							
Pass		1					
Nominal Flow (1)(2)	l/s	64.2	70.2	80.0	87.3	97.2	104.7
Pressure Drop (1)(2)	kPa	14.4	15.4	18.3	21.7	26.7	28.0
Minimum Flow	l/s	46.9	50.1	53.3	53.3	53.3	56.0
Maximum Flow	l/s	171.9	184.5	195.3	195.3	195.3	206.0
Water Connection Type		Grooved end					
Water Connection Size	in	8	8	8	8	8	8
Refrigerant							
Type		R-134a					
Charge Circuit 1	kg	176	180	181	178	197	197
Charge Circuit 2	kg	174	180	181	180	202	199
Dimensions & weight							
Length	mm	4586	4586	4586	4586	4586	4586
Width	mm	1840	1840	1840	1840	1840	1840
Height	mm	2395	2395	2395	2395	2395	2395
Operating weight	kg	7350	7450	8590	8590	9630	9680

- (1) Evaporator 12/7°C, condenser water temperature 30/35°C. Rated in accordance with AHRI Standard 551/591, based on TOPSS (Trane Official Product Selection Software) version 191.
- (2) Evaporator 12/7°C, condenser water temperature 30/35°C according to EN14511:2013.

General Data

RTHF HSE (High Seasonal Efficiency)

		330 HSE	360 HSE	410 HSE	460 HSE	500 HSE	540 HSE	590 HSE	640 HSE
Gross Cooling Capacity (1)	kW	1153.23	1260.0	1435.2	1564.2	1740.4	2057.8	2231.8	1153.3
Gross power input (1)	kW	207.5	229.4	261.5	287.5	319.0	342.1	389.0	437.1
Gross EER (1)		5.67	5.60	5.6	5.55	5.56	5.59	5.4	5.2
Gross ESEER (1)		7.99	8.28	8.54	8.20	8.66	8.61	7.96	7.84
IPLV (1)		8.395	8.753	8.949	8.746	8.660	8.752	8.638	8.499
Net cooling capacity (2)	kW	1149.9	1256.4	1431.5	1559.7	1735.7	1870.7	2050.4	2222.8
Net power input (2)	kW	212.6	234.8	267.6	294.8	327.5	352.3	402.0	452.7
Net EER (2)		5.52	5.46	5.46	5.40	5.41	5.42	5.20	5.01
Net ESEER (2)		7.36	7.60	7.82	7.43	7.81	7.73	7.07	6.87
Min Load	%	15%	15%	15%	15%	15%	15%	15%	15%
Compressor									
Circuit 1		1	1	1	1	1	1	1	1
Circuit 2		1	1	1	1	1	1	1	1
Evaporator									
Pass		1							
Nominal Flow (1)(2)	l/s	55.0	60.1	68.4	74.6	83.0	89.5	98.1	106.4
Pressure Drop (1)(2)	kPa	40.8	39.9	36.4	43.0	40.6	47.0	56.3	65.9
Minimum Flow	l/s	25.2	28.0	34.0	34.0	39.2	39.2	39.2	39.2
Maximum Flow	l/s	93.0	103.0	124.8	124.8.7	143.7	143.7	143.7	143.7
Water Connection Type		Grooved end							
Water Connection Size	in	8	8	8	8	8	8	8	8
Condenser									
Pass		1							
Nominal Flow (1)(2)	l/s	64.0	70.0	79.8	87.1	96.9	104.4	115.1	125.6
Pressure Drop (1)(2)	kPa	14.3	15.3	18.2	21.6	26.6	27.8	33.7	39.9
Minimum Flow	l/s	46.9	50.1	53.3	53.3	53.3	56.0	56.0	56.0
Maximum Flow	l/s	171.9	184.5	195.3	195.3	195.3	206.0	206.0	206.0
Water Connection Type		Grooved end							
Water Connection Size	in	8	8	8	8	8	8	8	8
Refrigerant									
Type		R-134a							
Charge Circuit 1	kg	176	180	181	178	197	197	196	194
Charge Circuit 2	kg	174	180	181	180	202	199	197	196
Dimensions & weight									
Length	mm	4586	4586	4586	4586	4586	4586	4586	4586
Width	mm	1940	1940	1940	1940	1940	1940	1940	1940
Height	mm	2395	2395	2395	2395	2395	2395	2395	2395
Operating weight	kg	7520	7620	8820	8820	9920	9970	9960	9960

- (1) Evaporator 12/7°C, condenser water temperature 30/35°C. Rated in accordance with AHRI Standard 551/591, based on TOPSS (Trane Official Product Selection Software) version 191.
- (2) Evaporator 12/7°C, condenser water temperature 30/35°C according to EN14511:2013.

Heating Performance

	40/45°C Entering/Leaving Condenser 10/7°C Entering/Leaving Evaporator				47/55°C Entering/Leaving Condenser 10/7°C Entering/Leaving Evaporator			
	Gross Heating cap (kW)	Gross COP	Net Heating cap (kW) (1)	Net COP (1)	Gross Heating cap (kW)	Gross COP	Net Heating cap (kW) (1)	Net COP (1)
RTWF 275 SE	1037.7	4.59	1041.4	4.37	973.8	3.70	974.8	3.61
RTWF 290 SE	1087.6	4.57	1091.8	4.34	1021.5	3.70	1022.6	3.6
RTWF 310 SE	1150.9	4.58	1155.2	4.35	1081.6	3.71	1082.7	3.61
RTWF 330 SE	1217.3	4.54	1221.7	4.38	1144.9	3.74	1146.1	3.64
RTWF 370 SE	1348.6	4.62	1353.8	4.39	1269.8	3.76	1271.2	3.65
RTWF 410 SE	1540.0	4.59	1547.7	4.39	1446.8	3.72	1448.3	3.62
RTWF 450 SE	1672.6	4.62	1678.8	4.39	1573.2	3.74	1574.8	3.65
RTWF 490 SE	1804.3	4.65	1810.6	4.43	1698.0	3.79	1700.3	3.68
RTWF 275 HE	1052.0	4.81	1053.8	4.62				
RTWF 290 HE	1103.5	4.80	1102.5	4.59	1040.3	3.90	1040.9	3.81
RTWF 310 HE	1171.3	4.79	1173.6	4.6	1104.0	3.90	1104.7	3.81
RTWF 330 HE	1235.1	4.89	1237.3	4.62	1164.9	3.93	1165.6	3.83
RTWF 370 HE	1359.3	4.88	1361.3	4.65				
RTWF 410 HE	1559.5	4.81	1562.2	4.6	1469.2	3.91	1470.0	3.82
RTWF 450 HE	1692.1	4.83	1695.1	4.72	1596.1	3.94	1596.9	3.84
RTWF 490 HE	1827.5	4.87	1830.5	4.68	1742.2	3.97	1725.0	3.88
RTWF 275 HSE	1057.8	4.76	1059.6	4.57				
RTWF 290 HSE	1111.2	4.74	1113.2	4.54	1049.7	3.86	1050.3	3.76
RTWF 310 HSE	1180.2	4.71	1182.6	4.53	1114.5	3.83	1115.2	3.75
RTWF 330 HSE	1243.6	4.76	1245.9	4.56	1175.6	3.87	1176.3	3.77
RTWF 370 HSE	1386.7	4.78	1388.8	4.55				
RTWF 410 HSE	1568.1	4.76	1570.8	4.55	1479.8	3.87	1480.6	3.70
RTWF 450 HSE	1701.1	4.78	1704.1	4.68	1606.6	3.89	1607.5	3.80
RTWF 490 HSE	1855.3	4.79	1858.4	4.60	1752.9	3.90	1753.8	3.81
RTWF 515 HSE	2032.6	4.7	2036.5	4.50	1924.1	3.86	1925.2	3.76

(1) according to EN14511:2013.

Operating Maps

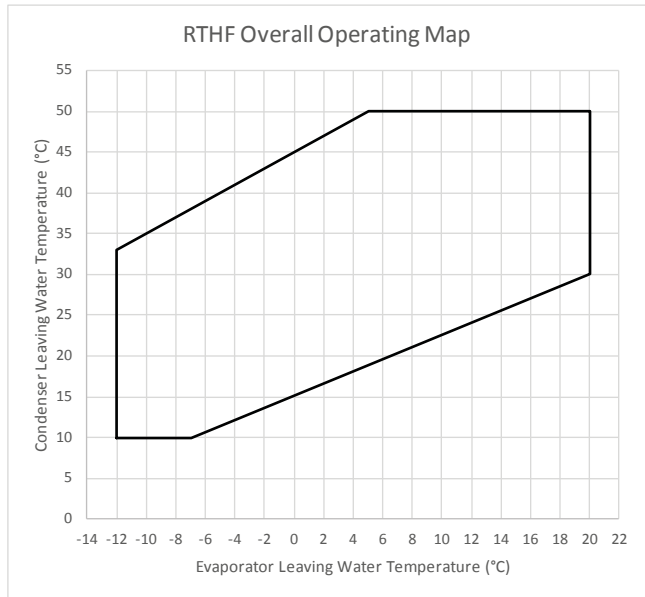
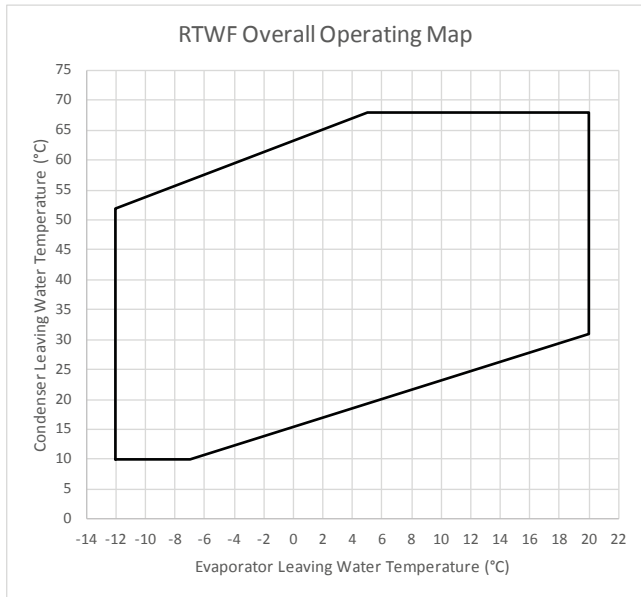

The charts above represent the overall operating limits of the unit, that is to say the limits within which unit will remain in operation. Some capacity limitations may occur depending on model and size when getting close to those limits. Always refer to Trane Official Product Selection Software output for actual operation limits of the selected unit.

Pressure drop

Evaporator pressure drop

RTWF SE - Evaporator pressure drop

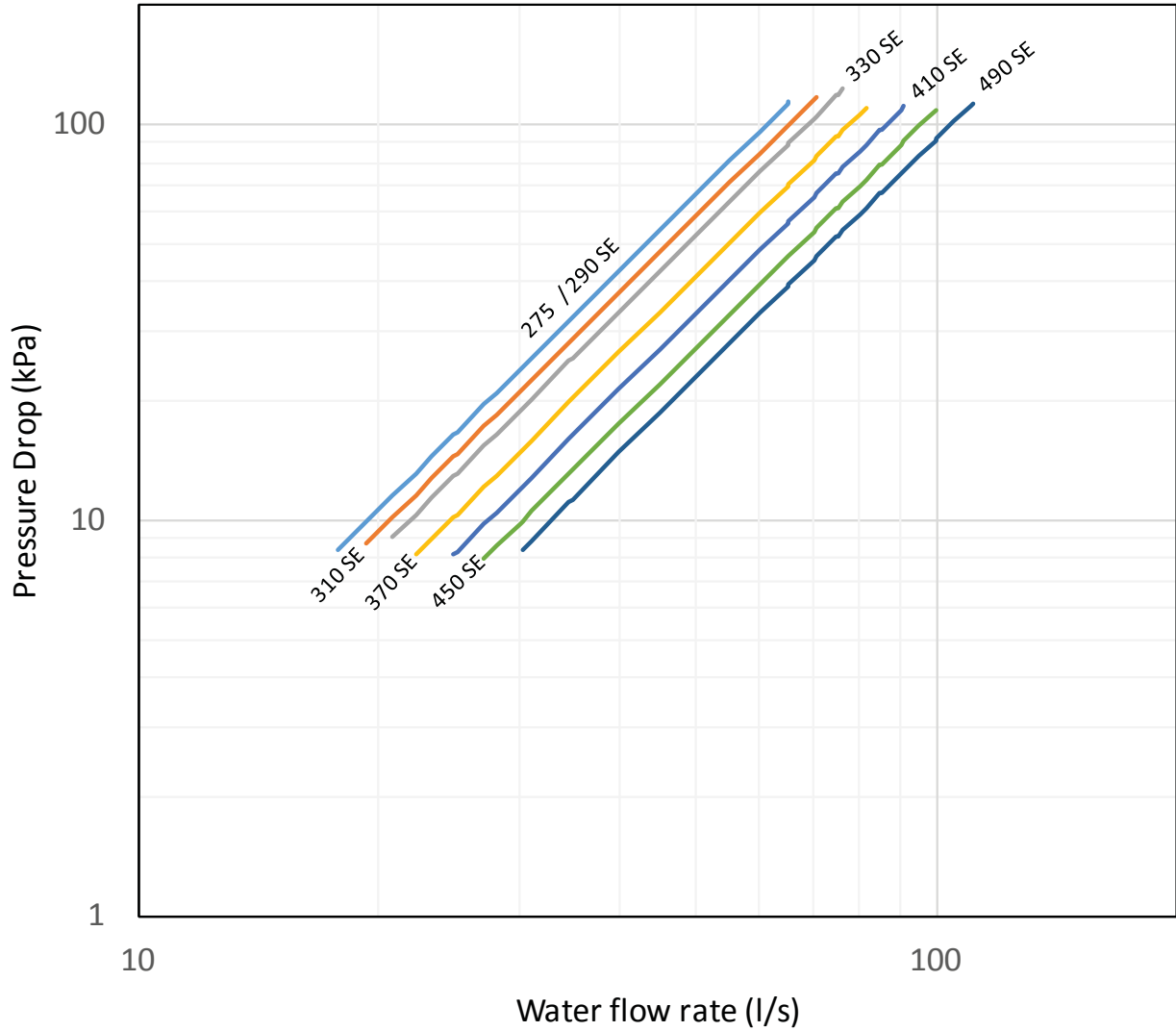

Pressure drop

RTWF HE/HSE- Evaporator pressure drop

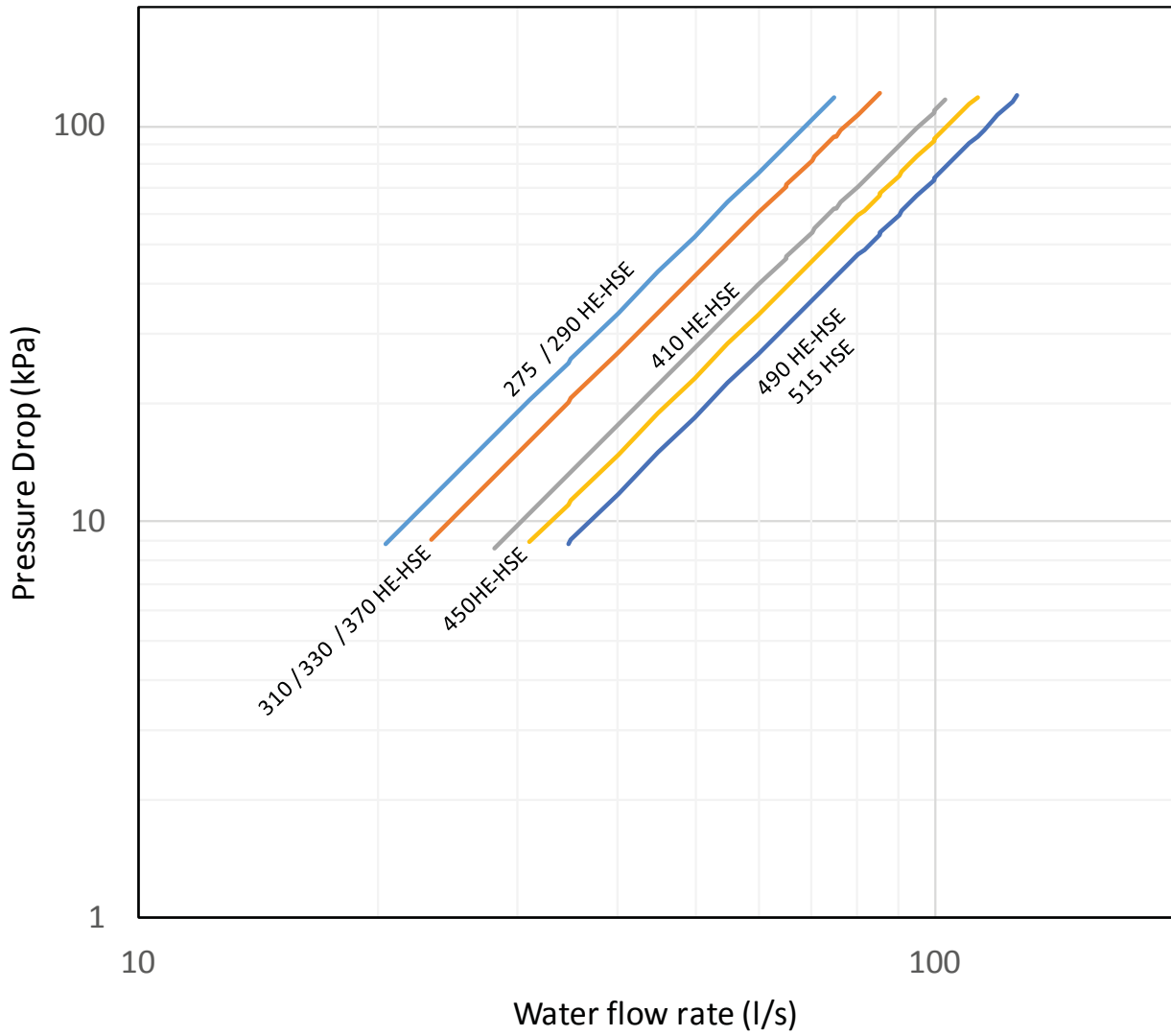

Pressure drop

RTHF XE/HSE - Evaporator pressure drop

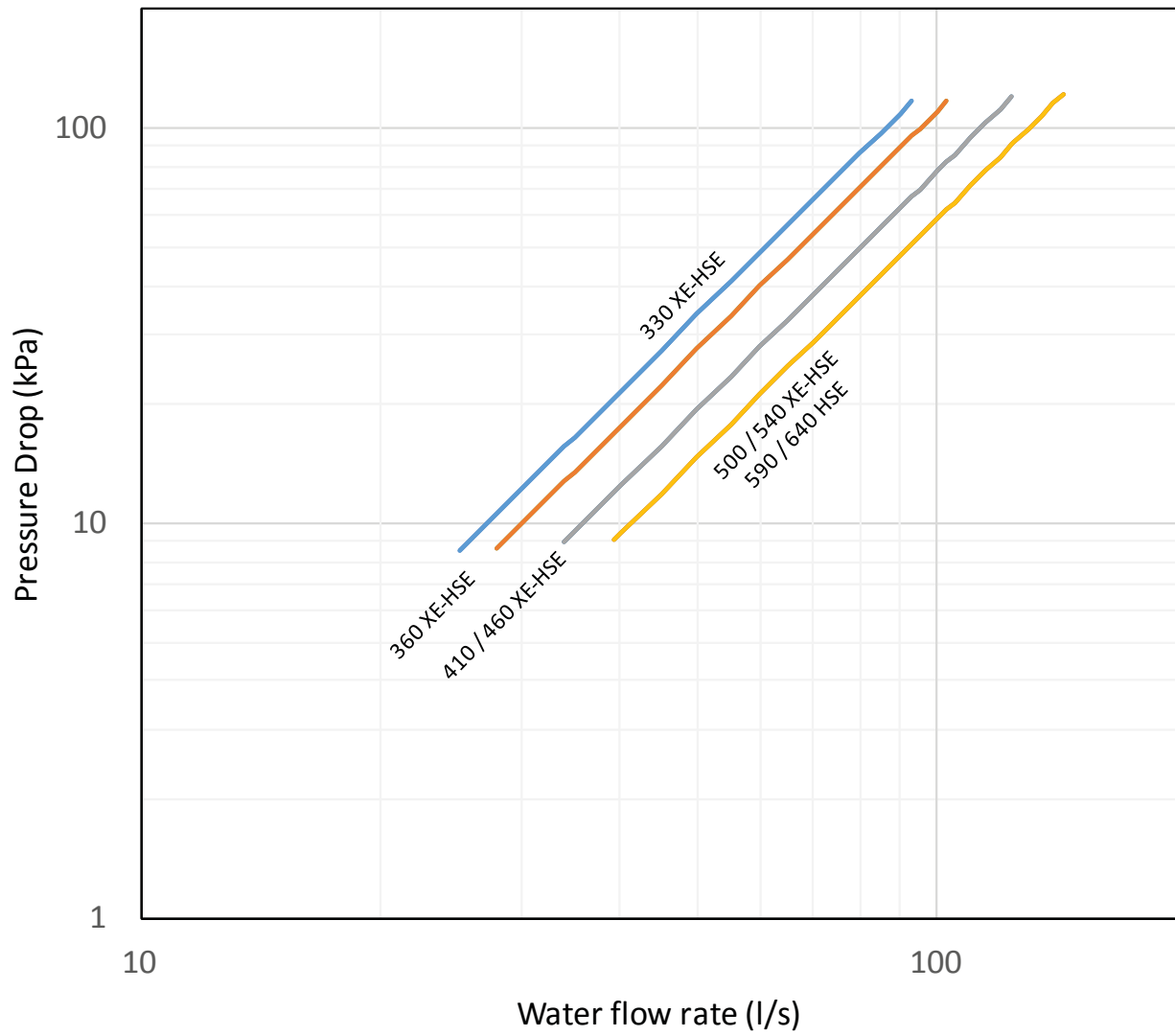

Pressure drop

Condenser pressure drop

RTWF SE - Condenser pressure drop

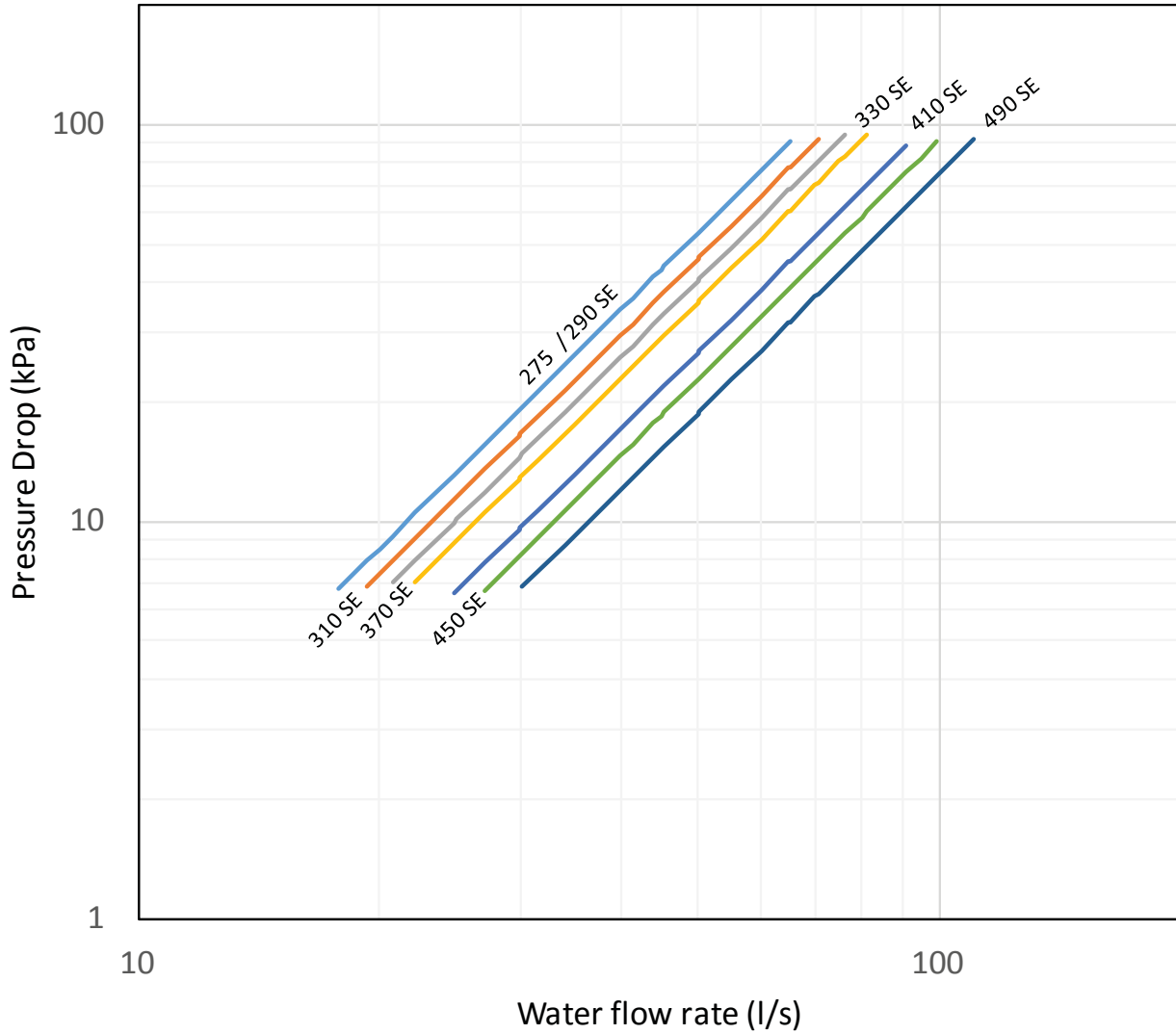

Pressure drop

RTWF HE/HSE- Condenser pressure drop

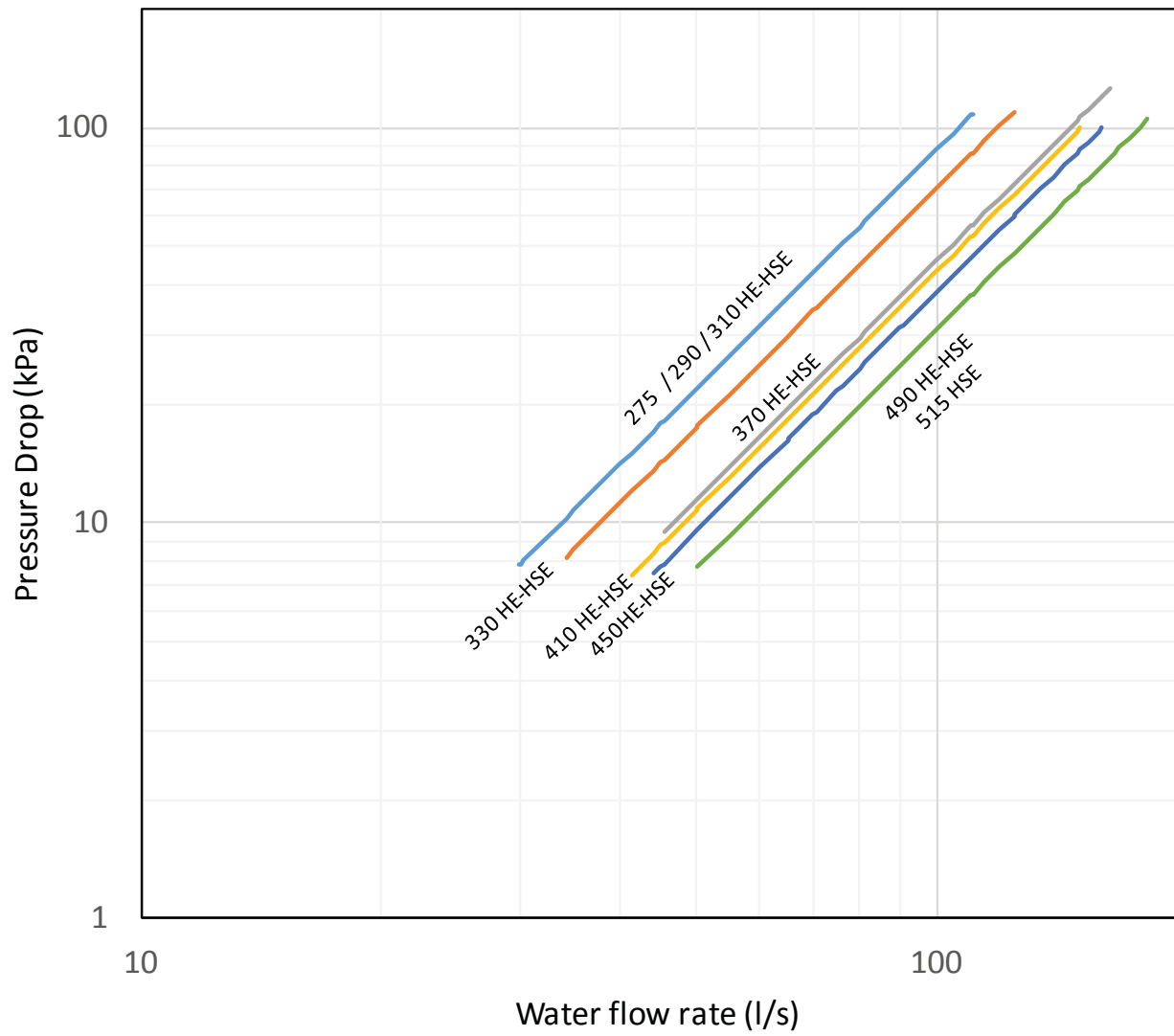

Pressure drop

RTHF XE/HSE - Condenser pressure drop

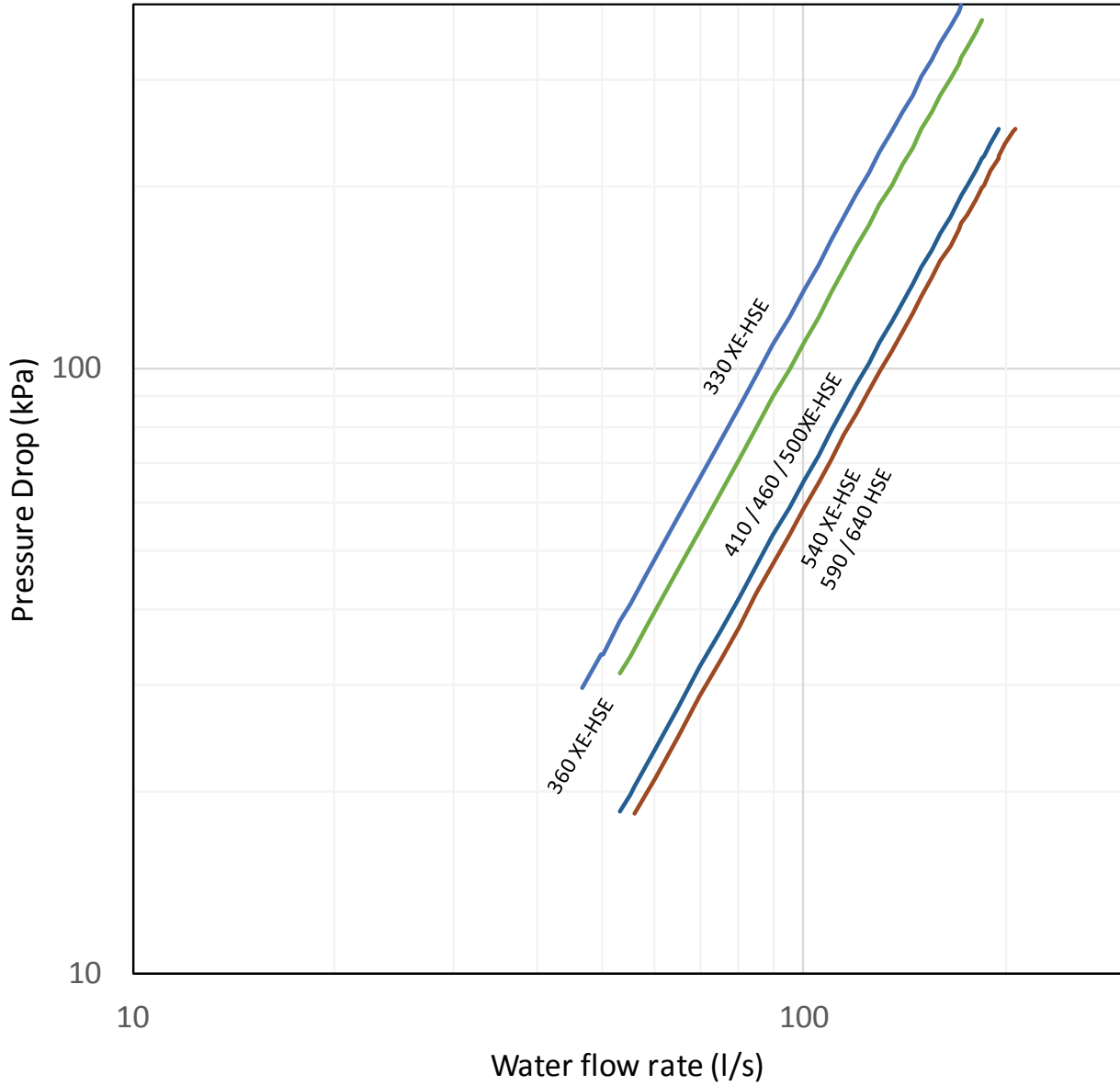

Electrical Data

			RTWF 275 SE	RTWF 290 SE	RTWF 310 SE	RTWF 330 SE	RTWF 370 SE	RTWF 410 SE	RTWF 450 SE	RTWF 490 SE
Std application	Max current	(A)	402	416	442	469	532	586	646	706
	Starting current	(A)	547	561	587	647	710	731	824	884
High condensing application	Max current	(A)	543	568	603	642	720	806	882	960
	Starting current	(A)	633	661	693	756	834	896	996	1074

			RTWF 275 HE	RTWF 290 HE	RTWF 310 HE	RTWF 330 HE	RTWF 370 HE	RTWF 410 HE	RTWF 450 HE	RTWF 490 HE
Std application	Max current	(A)	402	416	442	469	532	586	646	706
	Starting current	(A)	547	561	587	647	710	731	824	884
High condensing application	Max current	(A)	543	568	603	642	720	806	882	960
	Starting current	(A)	633	661	693	756	834	896	996	1074

			RTWF 275 HSE	RTWF 290 HSE	RTWF 310 HSE	RTWF 330 HSE	RTWF 370 HSE	RTWF 410 HSE	RTWF 450 HSE	RTWF 490 HSE	RTWF 515 HSE
Std application	Max current	(A)	381	398	420	450	509	566	626	685	750
	Starting current	(A)	526	543	565	628	687	711	804	863	928
High condensing application	Max current	(A)	519	543	578	617	688	779	857	928	957
	Starting current	(A)	609	633	668	731	802	869	971	1042	1071

			RTHF 330 XE	RTHF 360 XE	RTHF 410 XE	RTHF 460 XE	RTHF 500 XE	RTHF 540 XE
Std application	Max current	(A)	466	466	582	582	698	698
	Starting current	(A)	645	645	761	761	829	829

			RTHF 330 HSE	RTHF 360 HSE	RTHF 410 HSE	RTHF 460 HSE	RTHF 500 HSE	RTHF 540 HSE	RTHF 590 HSE	RTHF 640 HSE
Std application	Max current	(A)	450	450	549	549	649	649	702	773
	Starting current	(A)	450	450	549	549	649	649	702	773

Acoustic Data

	Global Sound Power SWL (dB(A))	Global Sound Pressure level at 10m SPL (dB(A))
RTWF 275 SE	100	68
RTWF 290 SE	100	68
RTWF 310 SE	101	69
RTWF 330 SE	101	69
RTWF 370 SE	101	69
RTWF 410 SE	102	70
RTWF 450 SE	102	70
RTWF 490 SE	102	70
RTWF 275 HE	100	68
RTWF 290 HE	100	68
RTWF 310 HE	101	69
RTWF 330 HE	101	69
RTWF 370 HE	101	69
RTWF 410 HE	102	70
RTWF 450 HE	102	70
RTWF 490 HE	102	70
RTWF 275 HSE	100	68
RTWF 290 HSE	100	68
RTWF 310 HSE	101	69
RTWF 330 HSE	101	69
RTWF 370 HSE	101	69
RTWF 410 HSE	102	70
RTWF 450 HSE	102	70
RTWF 490 HSE	102	70
RTWF 515 HSE	107	75
RTHF 330 XE	97	65
RTHF 360 XE	97	65
RTHF 410 XE	98	66
RTHF 460 XE	98	66
RTHF 500 XE	99	67
RTHF 540 XE	99	67
RTHF 330 HSE	97	65
RTHF 360 HSE	97	65
RTHF 410 HSE	98	66
RTHF 460 HSE	98	66
RTHF 500 HSE	99	67
RTHF 540 HSE	99	67
RTHF 590 HSE	102	70
RTHF 640 HSE	104	72



Notes



Trane optimizes the performance of homes and buildings around the world. A business of Ingersoll Rand, the leader in creating and sustaining safe, comfortable and energy efficient environments, Trane offers a broad portfolio of advanced controls and HVAC systems, comprehensive building services and parts. For more information visit www.Trane.com

Trane has a policy of continuous product and product data improvement and reserves the right to change design and specifications without notice.

© 2017 Trane All rights reserved
RLC-PRC058B-GB January 2017
New

We are committed to using environmentally
conscious print practices that reduce waste.

